

INSTRUCTIONS FOR SAFE OPERATION AND MAINTENANCE

⚠ DANGER

Understand manual before use. Operation of this device without understanding the manual and receiving proper training is a misuse of this equipment. Obtain safety information at www.tft.com/serial-number

⚠ DANGER

Risk of sliding increases at low elevation angles. To reduce risk of injury or death from sliding, test safety elevation plunger before using.

NOTICE

This Instruction Manual is intended to familiarize firefighters and maintenance personnel with the operation, servicing, and safety procedures associated with the portable monitor.

NOTICE

This manual should be kept available to all operating and maintenance personnel.

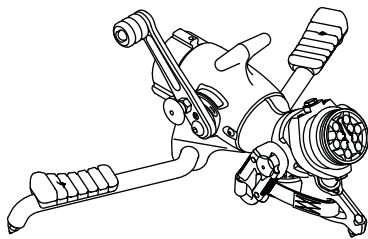

Blitz Force Portable Monitor

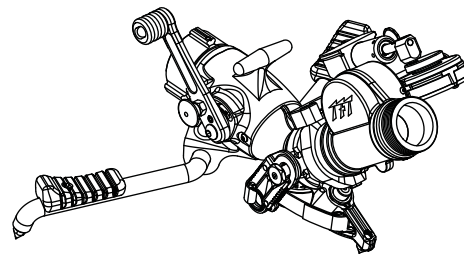

Blitz Force OSC Portable Monitor

MAXIMUM OPERATION PRESSURE
175 PSI (12 bar)

MAXIMUM FLOW
500 GPM (2000l/min)

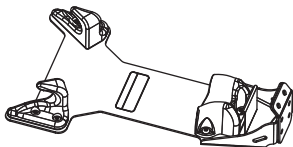

Blitz Force Mounting Bracket

⚠ DANGER

PERSONAL RESPONSIBILITY CODE

The member companies of FEMSA that provide emergency response equipment and services want responders to know and understand the following:

1. Firefighting and Emergency Response are inherently dangerous activities requiring proper training in their hazards and the use of extreme caution at all times.
2. It is your responsibility to read and understand any user's instructions, including purpose and limitations, provided with any piece of equipment you may be called upon to use.
3. It is your responsibility to know that you have been properly trained in Firefighting and /or Emergency Response and in the use, precautions, and care of any equipment you may be called upon to use.
4. It is your responsibility to be in proper physical condition and to maintain the personal skill level required to operate any equipment you may be called upon to use.
5. It is your responsibility to know that your equipment is in operable condition and has been maintained in accordance with the manufacturer's instructions.
6. Failure to follow these guidelines may result in death, burns or other severe injury.



Fire and Emergency Manufacturers and Service Association
P.O. Box 147, Lynnfield, MA 01940 • www.FEMSA.org

Table Of Contents

1.0 Meaning of Safety Signal Words	5.2 Anchoring by Spike Holds
2.0 General Information	5.3 Anchoring by Hooking Legs
2.1 Blitz Force Part Identification	5.4 Anchoring by Tying Off with Safety Strap
2.2 Valve Operation	6.0 OSC Oscillating Unit
2.3 Folding Legs	6.1 Safety - Oscillator
2.3.1 Carbide Spikes	6.2 General - Oscillator
2.4 Full-time Swivel Inlet Coupling	6.3 Oscillator
2.5 Outlet Pivots and Safety Elevation Plunger	6.4 Oscillating Speed and Coverage
2.5.1 Elevation Holding Mechanism	7.0 Storage
3.0 Flows and Pressures	8.0 Maintenance
3.1 Automatic, Fixed, and Selectable Flow Nozzles	9.0 Exploded View and Parts List
3.2 Stacked Tips or Smoothbore Nozzles	9.1 Blitz Force Portable Monitor Exploded View and Parts List
3.3 Stream Straighteners	9.2 Blitz Force Oscillator Exploded View
3.4 Use with Foam	10.0 XXL-B Storage Bracket Installation Instructions
3.5 Use with Salt Water	10.1 For Blind Mounting
3.6 Blitz Force Portable Monitor Pressure Loss	10.2 For Mounting Where Back Of The Mounting Surface Is Accessible
4.0 Deployment of Blitz Force Portable Monitor	10.3 Mounting Bracket Dimensions
4.1 Carrying with an Uncharged Hose	11.0 Bracket Exploded View and Parts List
4.2 Carrying with a Charged Hose	12.0 Warranty
5.0 Anchoring	13.0 Operation Checklist
5.1 Anchoring by Weight	

1.0 MEANING OF SAFETY SIGNAL WORDS

A safety related message is identified by a safety alert symbol and a signal word to indicate the level of risk involved with a particular hazard. Per ANSI standard Z535.6-2006, the definitions of the four signal words are as follows:



DANGER indicates a hazardous situation which, if not avoided, will result in death or serious injury.



WARNING indicates a hazardous situation which, if not avoided, could result in death or serious injury.



CAUTION indicates a potentially hazardous situation which, if not avoided, may result in minor or moderate injury.



NOTICE is used to address practices not related to personal injury.

2.0 GENERAL INFORMATION

The Blitz Force Portable Monitor is an efficient, compact and easy to maneuver portable monitor. The monitor is a lightweight aluminum unit, which can deliver 500 GPM of water. This monitor can be mounted in a pre-connected state on the truck-mounting bracket for achieving quick and effective initial attack. General product specifications are as follows:

- Standard Inlet Coupling: 2 ½ inch NH Female
- Standard Outlet: 2 ½ inch NH male
- Flow range: up to 500 GPM (2000 LPM)
- Maximum inlet pressure: 175 PSI (12 BAR)
- Vertical Stream Range: 20 to 60° above horizon manned
(30 to 60° above horizon unmanned)
- Horizontal Stream Range: +/- 20 degrees either side of centerline
- Size, legs folded: 14.8"L x 9.0"W x 9.4"H (375 x 230 x 240mm)
- Size, legs unfolded: 15"L x 25.8"W x 10"H (380 x 655 x 254mm)
- Weight: 15 lbs (6.9 kg)



This equipment is intended for use by trained personnel for firefighting. Its use for other purposes may involve hazards not addressed by this manual. Seek appropriate guidance and training to reduce risk of injury.



An out of control monitor can cause injury or death. To reduce the risk of instability, do not attempt to move the monitor with water flowing.



The flow from the monitor may be vital to keep a firefighter from injury or death. Avoid situations that may interrupt flow to the monitor such as: hose line kinks, traffic running over hose, and automatic doors or devices that can pinch the hose.



Master streams are powerful and capable of causing injury and property damage. Make sure the monitor is pointing in a safe direction before water to the nozzle is turned on. Use care in directing the stream.



Monitor must be properly connected to hose and nozzle. Mismatched or damaged threads may cause leaking or uncoupling under pressure and could cause injury.



Do not couple aluminum to brass. Dissimilar metal coupled together can cause galvanic corrosion that can result in inability to unscrew threads or complete loss of thread engagement.



Use with salt water is permissible provided the monitor is thoroughly cleaned with fresh water after each use. The service life of the monitor may be shortened due to the effects of corrosion and is not covered under warranty.

2.1 BLITZ FORCE PART IDENTIFICATION

Figure 2.1 identifies the various parts and controls of the Portable Monitor.

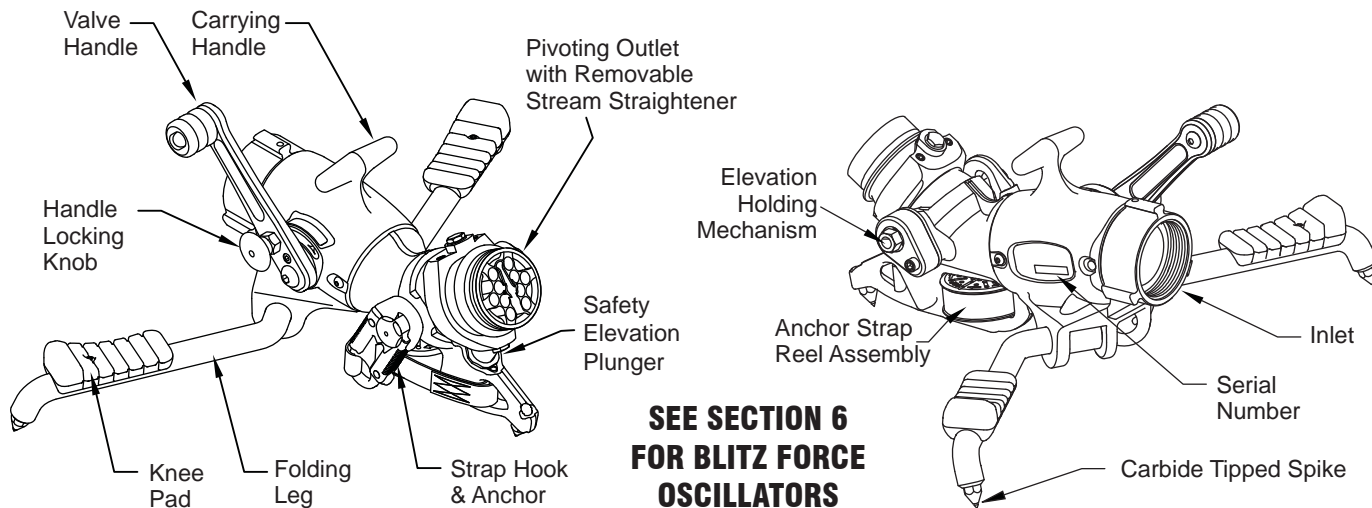

Figure 2.1 Portable Monitor Parts and Controls

2.2 VALVE OPERATION

The valve handle is locked in the closed position so that the Portable Monitor may be carried/moved without the valve inadvertently opening when water flow is not desired. To unlock the valve handle from the closed position:

1. Pull knob on right side of valve handle.
2. While pulling on knob move valve handle slowly to an open position with other hand.

As soon as valve is opened the knob may be released. Valve handle may be moved to any position by pushing or pulling on the valve handle. When the valve is closed the valve handle automatically locks and must be unlocked again to reopen. The monitor has a label that indicates the direction to open and close the valve. The valve opening procedure is shown in figure 2.2. Remember to close the valve slowly to reduce water hammer.

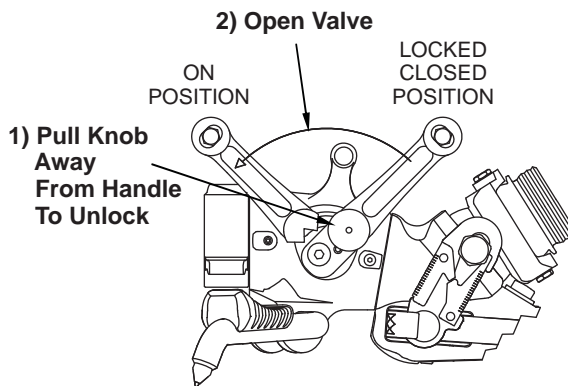

Figure 2.2 Valve Opening Procedure



Injury or death from an out of control monitor can occur. If monitor gets out of control, retreat from monitor immediately. Do not attempt to regain control of monitor while it is flowing.

To minimize the risk of an out of control monitor:

- Test Shut-off Valve before each use.
- Tie off the monitor when practical.
- Hook legs on stationary objects such as door frames, cracks, sign posts etc.
- Keep elevation as high as practical.
- Choose surfaces that allow spikes to dig in.
- Assure that the hose is not lifting the spikes off the ground.
- Reduce flow to limit nozzle reaction if stability is questionable.

2.3 FOLDING LEGS

The Portable Monitor has two legs that fold for storage and unfold for operation. The legs are held in the folded and unfolded position by spring detents. To fold or unfold the legs:

1. Grasp the spike end of one leg and pivot it to the folded or unfolded position.
2. Repeat for the other leg.



In the unfolded position the legs provide a stable base for operation of the monitor. Lack of stability can cause an out of control monitor resulting in injury or death. Do not operate as a portable monitor with either one or both legs in the folded position.

2.3.1 CARBIDE SPIKES

The Blitz Force Portable Monitor has 3 tungsten carbide tipped spikes on the legs and the base to resist sliding by digging into the surface the monitor is sitting on. The amount of sliding force these spikes can withstand depends upon the amount of downward and sideways force that is on the base and the hardness and texture of the surface the spikes are in contact with. At low elevation angles, it is difficult for these spikes to resist sliding. These spikes are essential to safe operation of the monitor and must be in contact with the ground at all times. Set the monitor on an even surface so that all three spikes contact the ground. Replace any spike if the tip diameter exceeds 1/16 inch (1.6 mm).



For stable operation the three spikes must maintain in contact with the ground. Do not place the monitor on top of debris, objects, or uneven terrain that would keep any of the spikes from contacting the ground.



On hard slippery surfaces the spikes may provide little resistance to sliding. In these cases the monitor should be tied off or the legs hooked on stationary objects to keep the monitor in position. Also, a person's weight applied to the monitor may help increase resistance to sliding.



Spikes must be sharp to provide resistance to sliding. Replace any spike if the tip diameter exceeds 1/16 inch (1.6 mm).



Spikes are sharp and exposed. Use care around spikes to avoid injury and damage to clothing or other property.

2.4 FULL TIME SWIVEL INLET HOSE COUPLING

The Blitz Force Portable Monitor has a full-time swiveling inlet coupling so that when the hose is charged, any twist in the hose will minimize the lifting of the spikes off the ground. The monitor is equipped with three spikes to provide traction when flowing from the ground. For the spikes to provide traction they must remain in contact with the ground. Assure that the hose is not on top of anything that would cause the spikes to be lifted off the ground.

2.5 OUTLET PIVOTS AND SAFETY ELEVATION PLUNGER

The monitor's outlet pivots allow for 20 degrees of horizontal rotation either side of center. The elevation range is from 20 to 60 degrees manned and 30 to 60 degrees unmanned. (30 to 50 degrees with the oscillator version) While manned, to lower the outlet below the 30 degrees elevation, just push down the outlet to the desired elevation. Below the outlet pivot is a spring-loaded plunger that returns the outlet to 30 degrees if the operator releases on the outlet or the monitor is unmanned. The pivots are easy to reposition under pressure and are good for rapid redirecting of the stream. Figure 2.5 shows the outlet pivots range of motion.

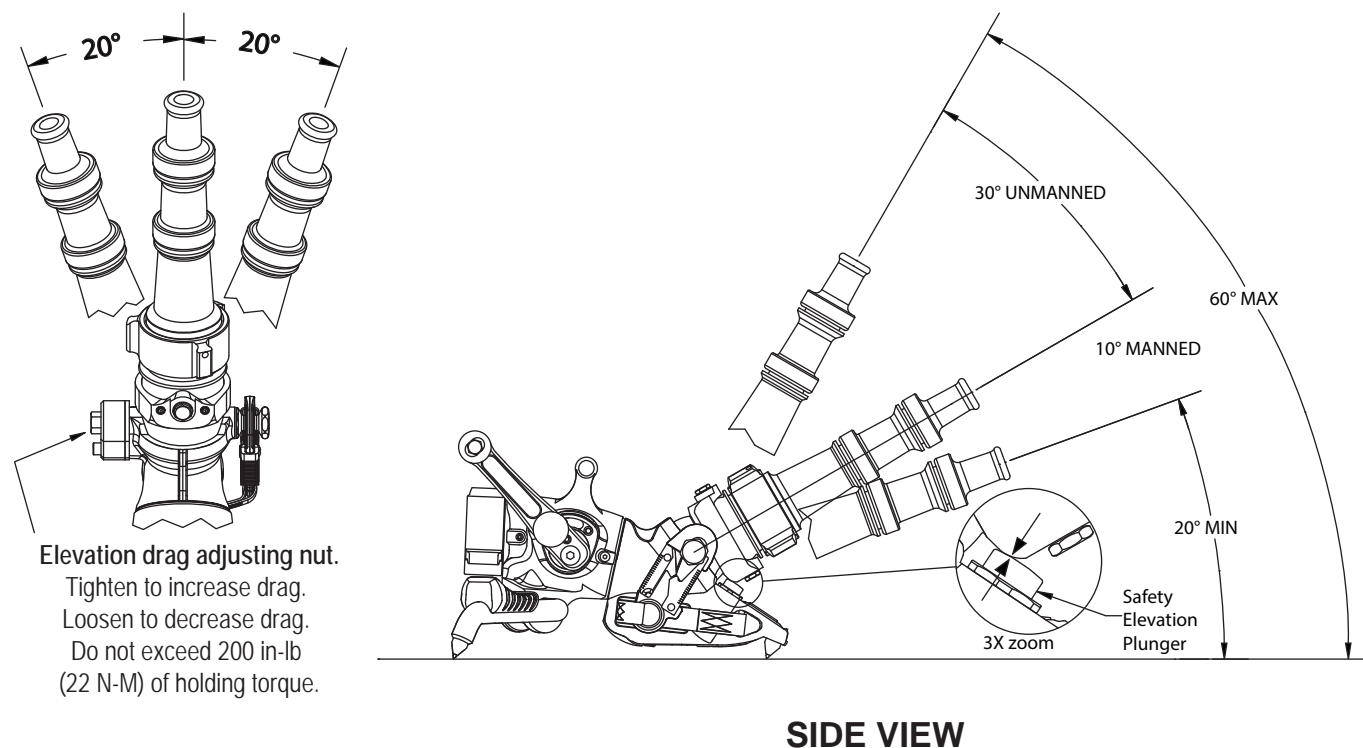

Figure 2.5 Outlet Pivot Range of Motion

2.5.1 ELEVATION HOLDING MECHANISM

The elevation pivot has a mechanism to support the weight of a nozzle. It is factory set to support the weight of nozzles likely to be used. It may be adjusted (see figure 2.5). The mechanism releases when raising the nozzle so upwards drag from the mechanism is not felt. Avoid the use of long stream straighteners or heavy nozzles which may overcome the holding torque of the elevation mechanism.

3.0 FLOWS AND PRESSURES

The Blitz Force Portable Monitor is designed for maximum flows of 500 GPM (2000 LPM) and a maximum pressure of 175 PSI (12 BAR). Do not exceed these limits.

⚠ WARNING An inadequate supply of pressure and/or flow will cause an ineffective stream and can result in injury, death or loss of property.

3.1 AUTOMATIC, FIXED, AND SELECTABLE FLOW NOZZLES

A variety of water or foam nozzles may be used with the Blitz Force Portable Monitor.

Automatic nozzles maintain a constant pressure by adjusting their opening to match the available flow. Consult the nozzle manufacturer for maximum flow and pressure ratings. In all cases do not exceed 500 GPM (2000 LPM) and/or 175 PSI (12 BAR).

3.2 STACKED TIPS OR SMOOTHBORE NOZZLES

NOZZLE DIAMETER	NOZZLE INLET PRESSURE									
	50 PSI		80 PSI		100 PSI		150 PSI		175 PSI	
	FLOW (GPM)	REACTION (LBS)	FLOW (GPM)	REACTION (LBS)	FLOW (GPM)	REACTION (LBS)	FLOW (GPM)	REACTION (LBS)	FLOW (GPM)	REACTION (LBS)
1.0 INCH	210	80	266	126	297	157	364	236	390	275
1-1/4 INCH	328	120	415	196	464	245	—	—	—	—
1-1/2 INCH	473	177	—	—	—	—	—	—	—	—

NOZZLE DIAMETER	NOZZLE INLET PRESSURE									
	4 BAR		6 BAR		8 BAR		10 BAR		12 BAR	
	FLOW (L/min)	REACTION (KG)	FLOW (L/min)	REACTION (KG)	FLOW (L/min)	REACTION (KG)	FLOW (L/min)	REACTION (KG)	FLOW (L/min)	REACTION (KG)
25 MM	830	40	1000	60	1200	80	1300	100	1400	120
32 MM	1300	70	1700	100	1900	130	—	—	—	—
38 MM	1900	90	—	—	—	—	—	—	—	—



FLOW EXCEEDS RATING OF BLITZ Force PORTABLE MONITOR

3.3 STREAM STRAIGHTENERS

Stream quality, especially with smooth bore nozzles, is generally improved with the use of a stream straightener. A stream straightener is integrated into the exit of the monitor.

3.4 USE WITH FOAM

The monitor may be used with various foam nozzles and foam solutions. Refer to fire service training for the proper use of foam.

3.5 USE WITH SALT WATER

Use with salt water is permissible provided the monitor is thoroughly cleaned with fresh water after each use. The service life of the monitor may be shortened due to the effects of corrosion and is not covered under warranty.

3.6 BLITZ FORCE PORTABLE MONITOR PRESSURE LOSS

Figure 3.6 gives the pressure loss for the Blitz Force Portable Monitor

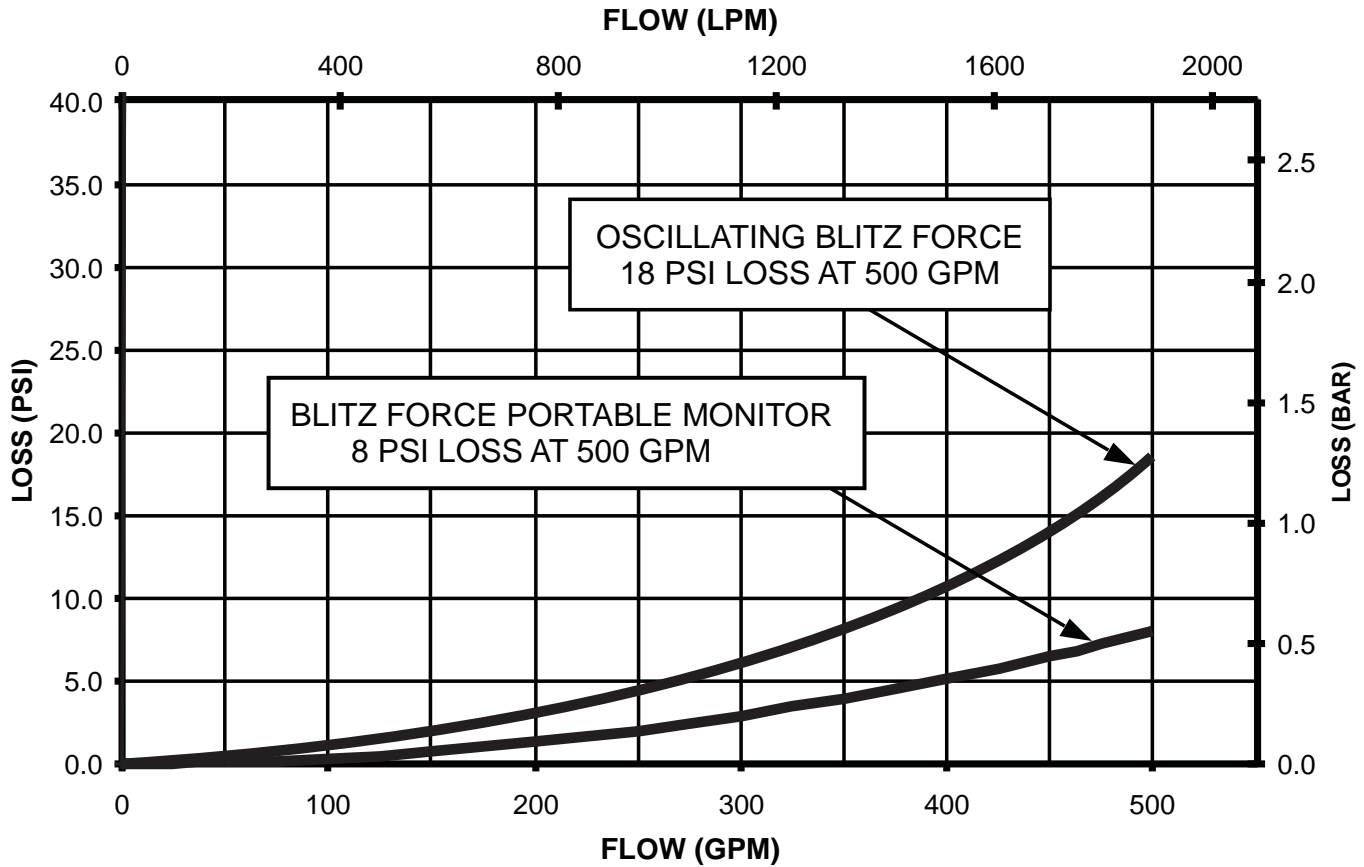

Figure 3.6 Blitz Force Pressure Loss

4.0 DEPLOYMENT OF BLITZ FORCE PORTABLE MONITOR

It is the responsibility of the individual fire department or agency to determine physical capabilities and suitability for an individual's use of this equipment.

4.1 CARRYING WITH AN UNCHARGED HOSE

On a preconnected hoseline the monitor may be carried by the T-shaped handle or over the shoulder with the legs folded as illustrated in figure 4.1.

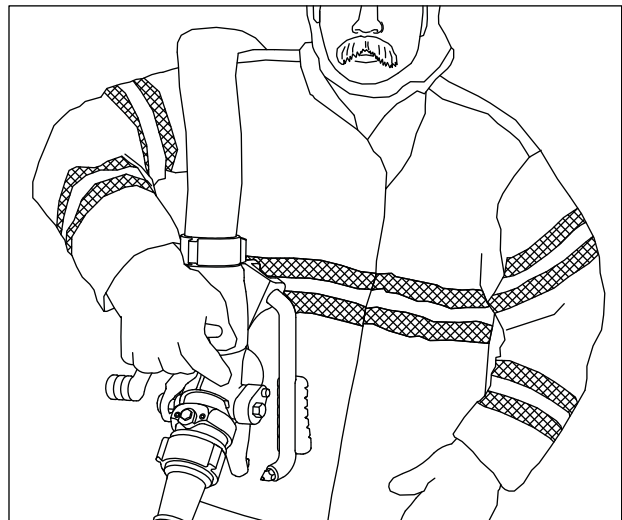
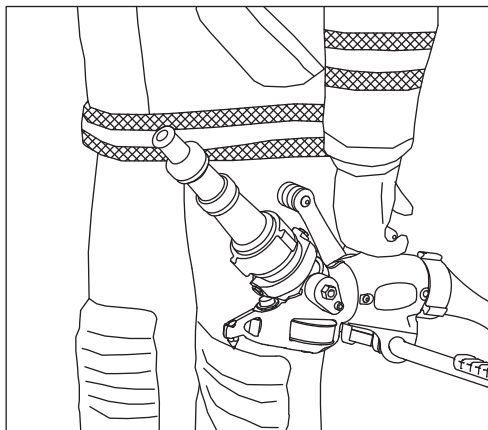

Figure 4.1 Carrying the Blitz Force on an Uncharged Hose

4.2 CARRYING WITH A CHARGED HOSE

On a charged hose the Blitz Force Portable Monitor may be carried by holding the T-shaped handle located on top of valve body as shown in figure 4.2. Shut-off valve handle should be locked in the closed position to keep the valve from inadvertently opening.

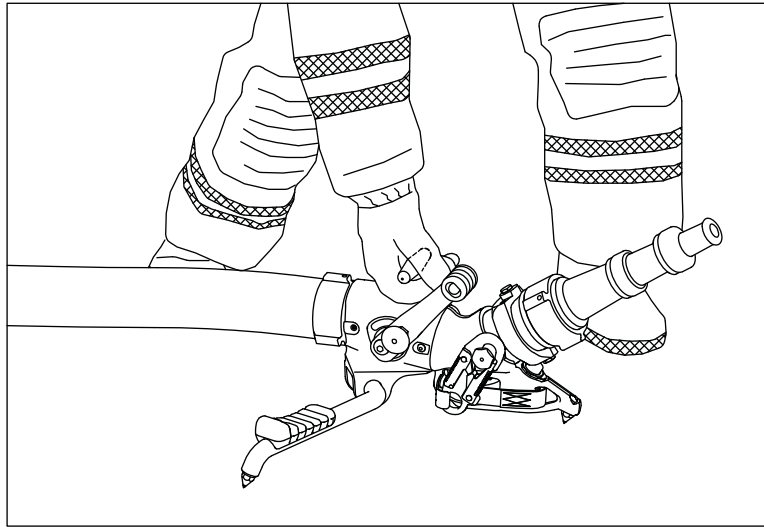

Figure 4.2 Carrying the Monitor with a Charged Hose

5.0 ANCHORING

The nozzle reaction force on the Blitz Force Portable Monitor may be as high as 330 lbs - 500 GPM at 175 PSI (150 kg- 2000 LPM at 12 BAR). This nozzle reaction must be restrained to keep the monitor from moving.

The monitor should be anchored from moving by one or more of these methods:

METHOD	RISK of MOVING
Anchoring by Weight	High
Anchoring by Spike Holds	Medium
Hooking legs on vertical surfaces	Medium
Using a tie off strap	Low

5.1 ANCHORING BY WEIGHT

On surfaces with good traction a person's weight on the monitor and/or hose may be sufficient to keep the monitor from sliding. This is highly dependant on the friction of the surface. The ability to keep one or more people's weight on the monitor is subject to operator fatigue and may not be as reliable as other methods. Operating at limited flows will reduce the risk.

5.2 ANCHORING BY SPIKE HOLDS

The holding ability of the spikes is generally excellent on surfaces like asphalt, wooden and carpeted floors because they allow the spike to penetrate well. On hard smooth surfaces such as ceramic tile, smooth concrete, marble, terrazzo, or steel decking the Blitz Force Portable Monitor's spikes may not hold well. Placing the spikes into cracks, expansion joints, or gratings or the like will help hold the monitor from sliding. Even with the spikes anchored, sliding may be caused by the surface cracking under the load, or from the hose or nozzle moving the monitor thereby dislodging the spikes from their hold. Figure 5.2 shows a close up of a spike caught in a crack.

The holding ability of the spikes on soft surfaces such as sand, gravel and mud is generally poor, therefore other anchoring methods should be considered.

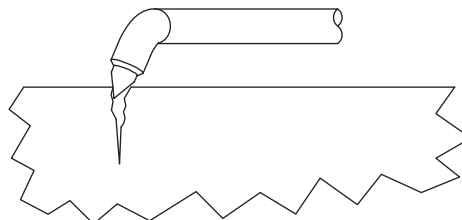
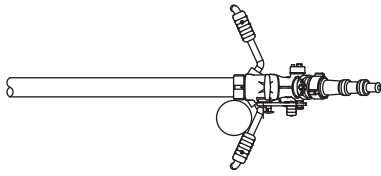

Figure 5.2 Spike Caught in a Crack

5.3 ANCHORING BY HOOKING LEGS

The legs on the Blitz Force Portable Monitor point back slightly so they can act as a hook for anchoring on posts, walls, door frames or other fixed objects. Sliding can occur if the legs are unhooked due to the influence of the hose, nozzle, or operator. See figure 5.3 for illustrations of this.



Good
Nozzle reaction keeps leg hooked.
Object is close to hose.

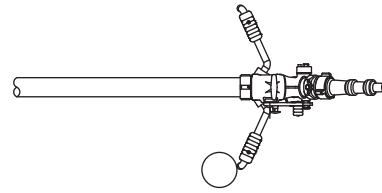

Poor
Nozzle reaction tends to unhook leg

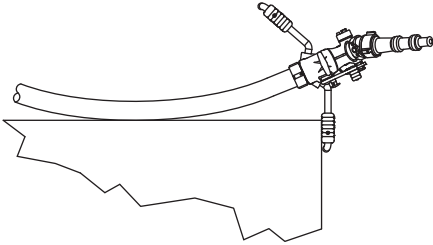

Good
Nozzle reaction keeps leg hooked.
Hose hits wall and helps hold position.

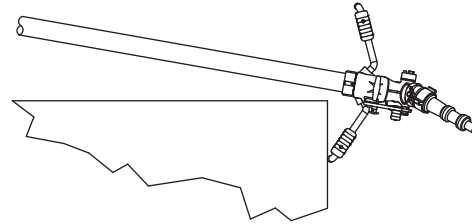

Poor
Nozzle reaction tends to unhook leg.

Figure 5.3 Hooking Legs to Gain Support

5.4 ANCHORING BY TYING OFF WITH SAFETY STRAP

The safest method of restraining the monitor is to use a tie down strap. It is inherently more reliable than other methods since it does not rely on traction or digging in of the spikes. It is also the safest method because even if the monitor slides its travel is limited by the strap length. Permanently anchored from the factory is a safety strap system that comes with a storage take-up reel attached to the mid-length of the strap and a safety hook attached to the other end of the strap, which may be wrapped around an object, such as a tree, and snap back onto the strap itself and pulled tight. Keep the entire length of the strap as close to the ground as possible. If the strap is too short to reach a suitable anchor,

it may be extended with strong rope or chain. Keep the distance between the monitor and anchor as short as possible. Remove all slack between the monitor and anchor before flowing water. Figure 5.4 shows the deployment method for the strap mechanism and the elements of tying off the monitor.

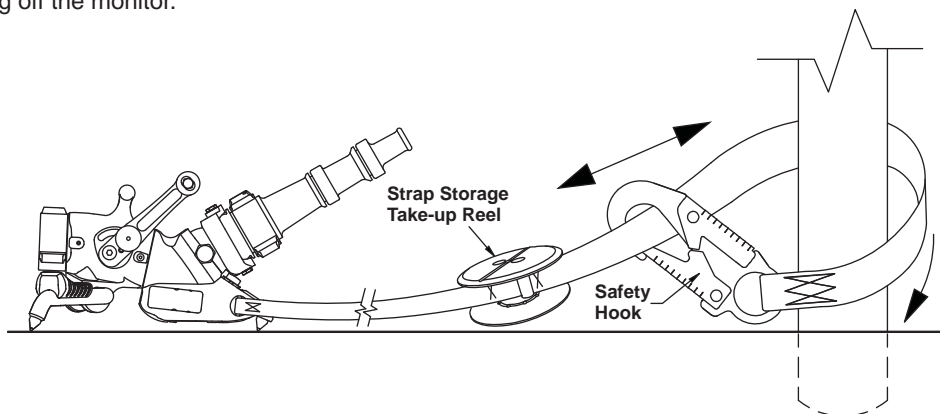
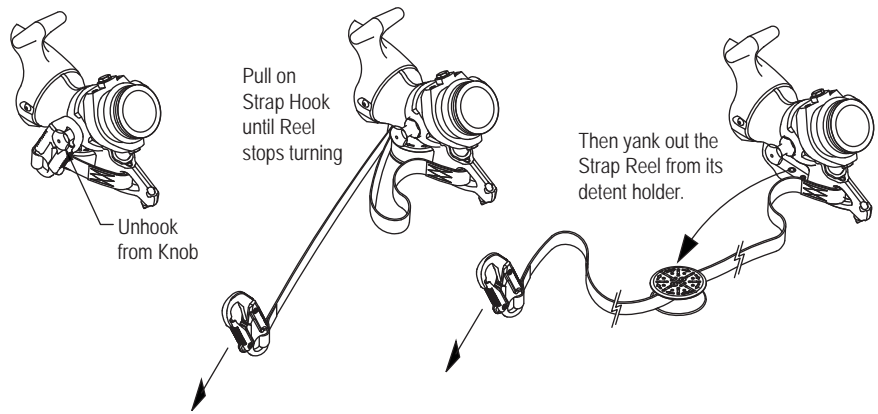

Figure 5.4 Tying Off of Blitz Force Portable Monitor

6.0 OSC OSCILLATING UNIT

An automatic oscillating mechanism is available for the Blitz Force Monitor. The Blitz Force Monitor can be purchased with the oscillating mechanism factory installed or added at the factory later.

6.1 SAFETY - OSCILLATOR

⚠ DANGER

Do not attempt to modify this oscillating mechanism to fit any other monitor. To do so will cause the reaction force of the nozzle to be unaligned with the center of rotation. The monitor may spin very fast with a very high force.

⚠ WARNING

Keep hands and fingers away from the moving parts of the oscillating unit when water is flowing. There are moving parts that can pinch fingers and hands.

⚠ WARNING

Make sure the Blitz Force is on a firm surface with adequate holding power. As the nozzle goes back and forth, the reaction force is acting in different directions on the leg spikes. Surfaces such as asphalt, turf and dirt generally have good holding power. Surfaces like concrete and loose gravel hold poorly.

⚠ CAUTION

Because the nozzle attached to the Blitz Force must slow down, stop and reverse direction at the end of each sweep, the ends of the covered area will receive more water than the center. If the center area of coverage needs the most cooling, occasionally narrow the area of coverage or use the oscillator manually.

6.2 GENERAL - OSCILLATOR

The Blitz Force oscillating mechanism can be used for exposure protection, cooling, or any other situation where it is desirable to have a monitor sweep back and forth.

The oscillating mechanism is driven by a turbine wheel. A worm gear drive reduces the speed and increases the torque of the turbine wheel. A simple crank mechanism makes the outlet of the Blitz Force and the nozzle attached to it move back and forth. The horizontal sweep can be set for a 20, 30 and 40 degree sweep. The oscillating mechanism can be uncoupled and the water stream can be aimed manually.

The speed of oscillation is a function of flow rate, see the Blitz Force Oscillation Speed graph on page 10. A minimum flow rate of 175 GPM is required for proper oscillator operation.

6.3 OSCILLATOR

Operating details for the Blitz Force Oscillator are shown in figure 6.3.

The Blitz Force's oscillator is protected by a shock absorber system. If the nozzle encounters an obstruction the shock absorber will compress or extend as needed to protect the gears from overload.

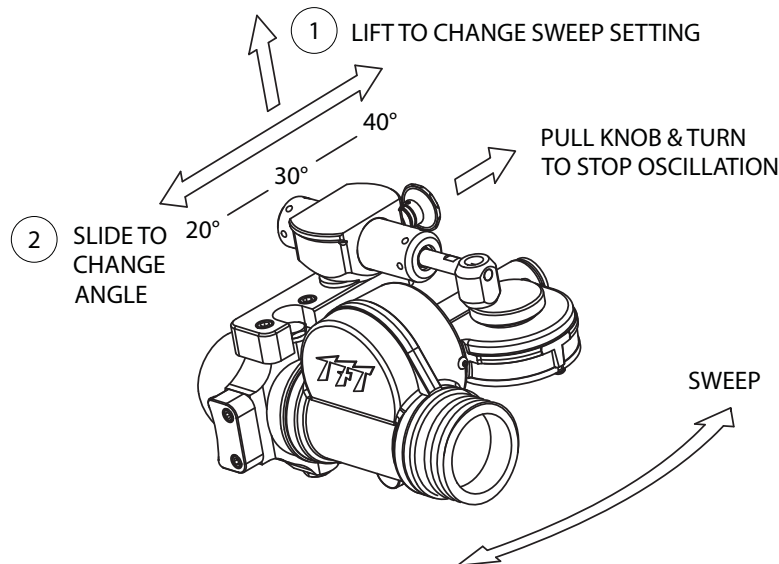

Fig. 6.3 Blitz Force Monitor Oscillator

6.4 OSCILLATION SPEED AND COVERAGE

Oscillation speed: The chart shows how many times per minute the oscillator makes one complete cycle as a function of flow. The higher the flow, the faster it oscillates.

For nozzle reach, refer to the operation manual for the specific nozzle. For reach with oscillation, subtract 20% from the distance.

APPROXIMATE CYCLES/MIN	GPM	L/MIN
8	175	650
13	250	1000
21	375	1500
28	500	2000

BLITZ FORCE OSCILLATION SPEED

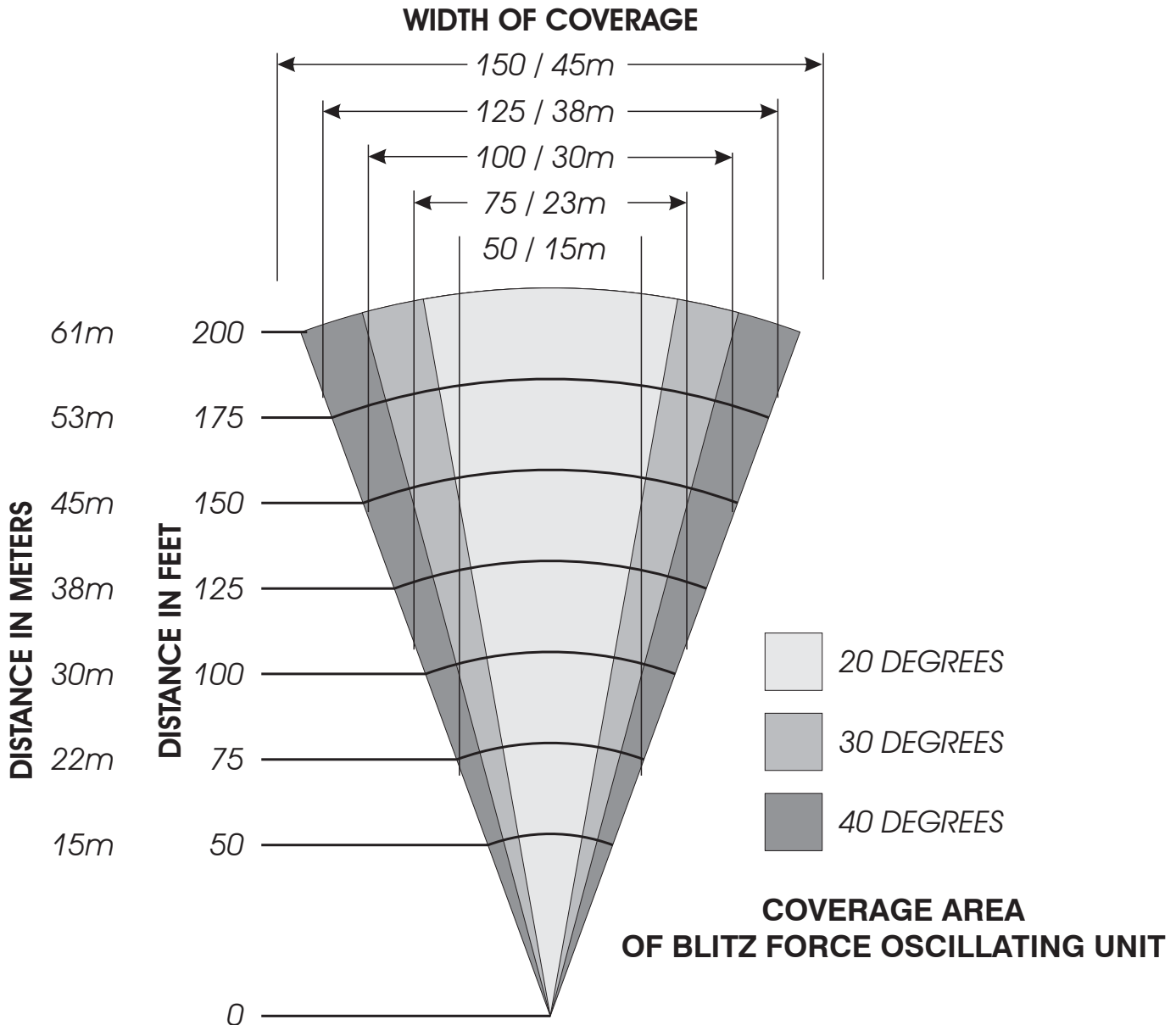

Fig. 6.4 Oscillation Speed and Coverage

NOTICE

The type of nozzle and flow pressure are critical to the coverage area. The graph shows coverage area based on the movement capability of the oscillating mechanism. Actual coverage will depend on flow, pressure, type of nozzle, angle of fog pattern and wind conditions.

7.0 STORAGE

The monitor may be stored pre-connected to its hose on the optional storage bracket, TFT part number XXL-B. The storage bracket may be mounted on a horizontal surface, or a vertical surface with the nozzle end pointing down or sideways. To mount the bracket follow the instructions provided with the bracket kit.

WARNING

The storage bracket is not intended to support the nozzle reaction forces from a flowing monitor.

8.0 MAINTENANCE

The Blitz Force Portable Monitor requires little maintenance. The unit should be kept clean and free of dirt by rinsing with water after each use. Any inoperable or damaged parts should be repaired or replaced before placing the unit in service.

CAUTION

Any alterations to the Blitz Force Portable Monitor and its markings could diminish safety and constitutes a misuse of this product.

MAINTENANCE CHECK LIST:

- Valve handle moves smoothly without binding (see section 2.2)
- Valve label legible
- Legs pivot freely and detents hold folded or unfolded position
- Spikes are sharp. Replace if tip diameter exceeds 1/16 inch (1.6 mm).
- Inlet coupling rotates freely
- Pull pin for Valve Handle locking locks and releases easily
- Outlet pivots freely from side to side
- Outlet pivots freely upward
- Outlet pivot has sufficient drag to support weight of nozzle
- Depress and release the outlet pivot against the Safety Elevation Plunger to verify upward spring return action
- Tie down strap is in good condition; no frays on strap or damage to hook

9.0 EXPLODED VIEWS AND PARTS LISTS

9.1 BLITZ FORCE PORTABLE MONITOR EXPLODED VIEW

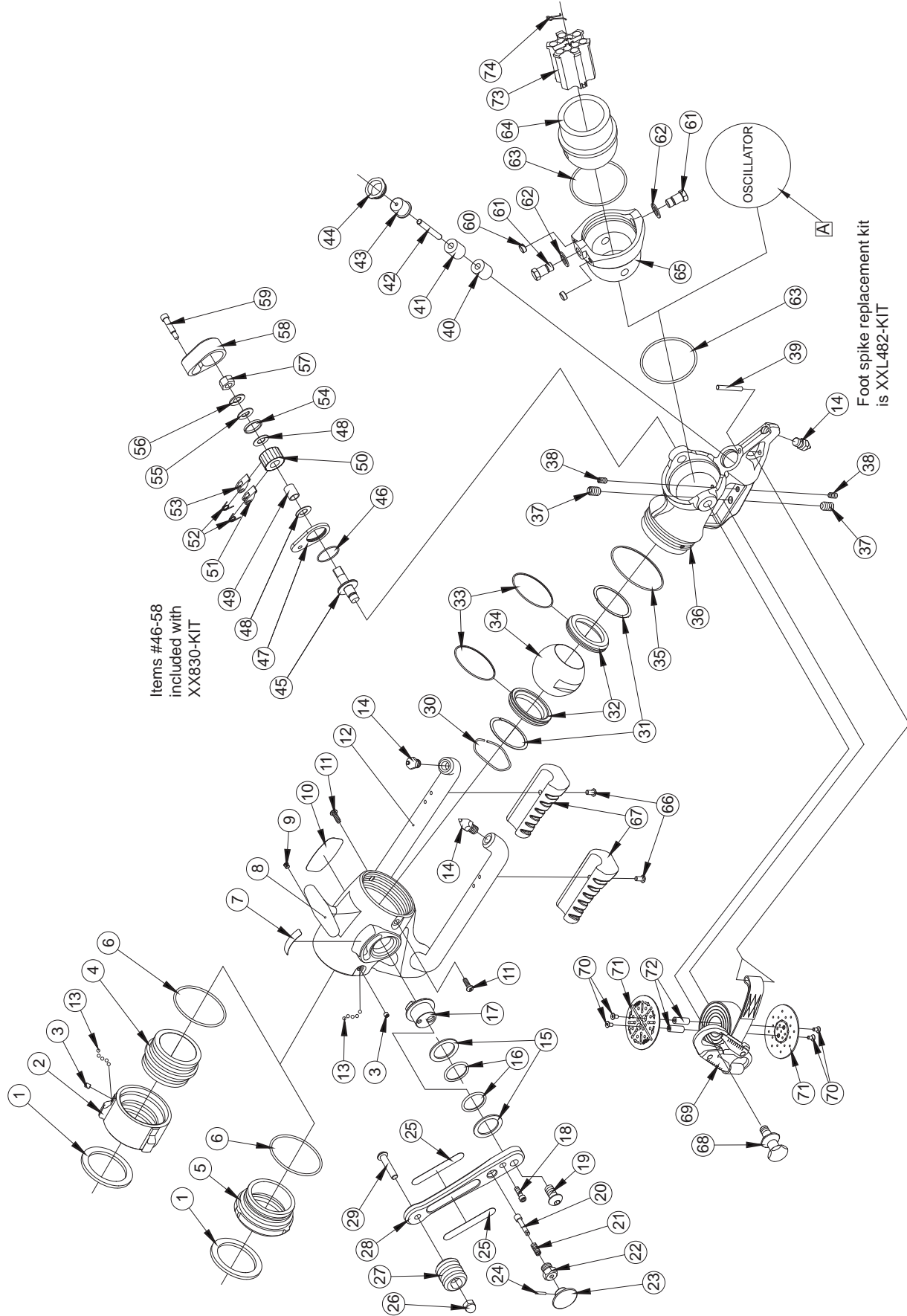

9.1 BLITZ FORCE PORTABLE MONITOR PARTS LIST

INDEX	DESCRIPTION	QTY	ITEM #
1	GASKET 2.5"	1	V3190
2	COUPLING 2.5"	1	M307*
3	1/4-28 X 1/2 SOCKET SET SCREW	1	VT25-28SS500
4	INLET MATE 3.0" MALE	1	XXL605
5	ADAPTER 2.5"BSPF X 3.0"HSBGM	1	XXL606
6	O-RING-151	1	VO-151
7	LABEL: OPEN/CLOSE	1	XXL660
8	INLET	1	XXL600
9	DOME PLUG	1	VM4124
10	NAME LABEL: BLITZFORCE PORTABLE MONITOR	1	XXL670
	NAME LABEL: PARTNER LITE GROUPE LEADER	1	XXL670-F
11	1/4-28 X 3/4 BUTTON HEAD SCREW	2	VT25-28BH750
12	LEG ASSEMBLY	1	XXL905
13	3/16" SS BALL	96	V2120
14	SPIKE	3	X482
15	TRUNNION SHIM	2	P330
16	O-RING-219	2	VO-219
17	TRUNNION	1	XXL325
18	1/4-20 X 3/4 SOCKET HEAD SCREW	1	VT25-20SH750
19	1/2-13 X 1.0 BUTTON HEAD SCREW	1	VT50-13BH1.0
20	PULL PIN	1	XXL340
21	PULL PIN SPRING	1	X345
22	PULL PIN HOUSING	1	XX355
23	PULL KNOB	1	XX341
24	1/8 X 3/4 HDP SPIROL PIN	1	VP125X750H
25	HANDLE LABEL: BLITZFORCE PORTABLE MONITOR	2	XXL626
	HANDLE LABEL: PARTNER LITE - FRENCH	2	XXL626-F
26	3/8-16 ACORN NUT	1	VT37-16AC
27	SINGLE HANDLE TOP	1	XXL625
28	SHUTOFF HANDLE	1	XXL620
29	3/8-16 X 1-3/4 BUTTON HEAD SCREW	1	VT37-16BH1.7
30	WAVE SPRING	1	V4310
31	SHIM	2	V4300
32	VALVE BALL SEAT 2.5"	2	P315
33	O-RING-038	2	VO-038
34	VALVE BALL 2.5"	1	P305
35	O-RING-236	1	VO-236
36	OUTLET	1	XXL420
37	PLUNGER 1/2-13 X 3/4 .281" BALL	2	XXL505

INDEX	DESCRIPTION	QTY	ITEM #
38	PLUNGER 5/16-18 X 37/64 .156" BALL	2	XXL506
39	STRAP PIN	1	XXL585
40	SPRING URETHANE	1	XXL583
41	SPRING 80A URETHANE	1	XXL584
42	PLUNGER PIN	1	XXL580
43	PLUNGER HEAD	1	XXL581
44	PLUNGER RETAINER	1	XXL582
45	CLUTCH TRUNION	1	XX325
46	O-RING-027	1	VO-027
47	CLUTCH BASE	1	XX336
48	WASHER	2	VW1.0X500-03
49	NYLON SLEEVE	1	XX334
50	RATCHET	1	XX333
51	PAWL 37 1/2 DEGREE	1	XX332
52	TORSION SPRING	2	XX338
53	PAWL 40 DEGREE	1	XX331
54	DIRT SEAL	1	XX339
55	D-WASHER	1	XX350
56	BELLEVILLE WASHER	1	VW1.0X512-BV
57	1/2-20 HEX NUT	1	VT50-20NT
58	CLUTCH HOUSING	1	XX337
59	5/16 X 1 SOCKET HEAD SHOULDER SCREW	1	VT31-00SB1.0
60	5/16-18 X 1/4 SOCKET SET SCREW	2	VT31-18SS250
61	SWIVEL TRUNNION	2	XX320
62	WAVE SPRING WASHER	2	VW740X550-16
63	O-RING-235	2	VO-235
64	EXIT 2.5"	1	XX310*
65	EXIT SEGMENT	1	XX305
66	1/4-20 X 1/2 BUTTON HEAD SCREW	2	VT25-20BH500
67	KNEE PAD	2	XXL477
68	SWIVEL TRUNNION/KNOB	1	XXL320
69	STRAP ASSEMBLY	1	XXL455-R
70	10-24 X 3/8 FLAT HEAD SCREW	4	VT10-24FH375
71	STRAP REEL FLANGE	2	XXL501
72	STAND OFF	2	XXL502
73	EXIT FIN INSERT	1	XXL405
74	EXIT FIN INSERT CLIP	1	XXL407
A	OSCILLATOR	1	SEE SECTION 8.2

9.2 BLITZ FORCE OSCILLATOR EXPLODED VIEW

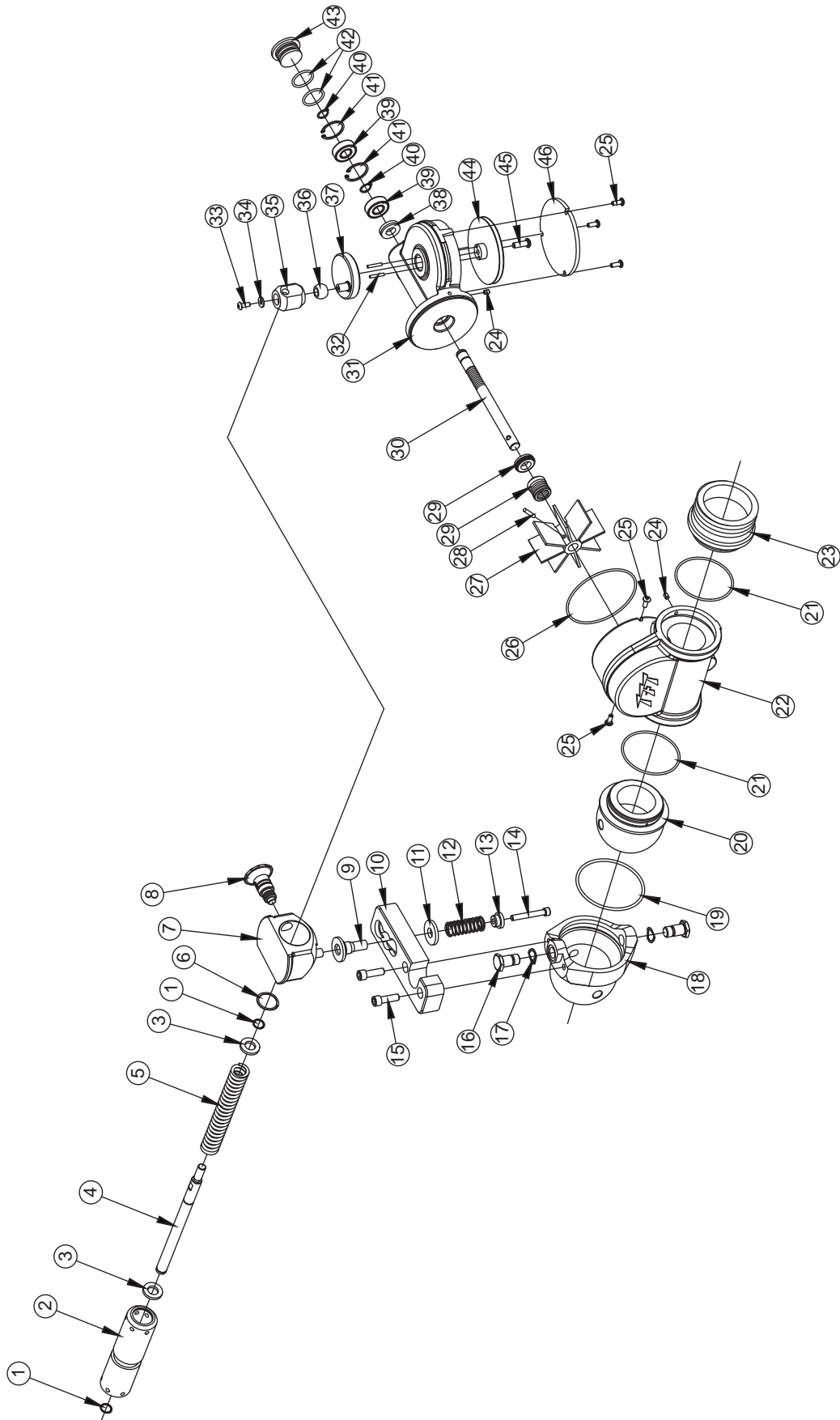

9.2 BLITZ FORCE OSCILLATOR PARTS LIST

INDEX	DESCRIPTION	QTY	ITEM #
1	SMALLEY RING	2	V4280
2	SPRING TUBE	1	XX367
3	WASHER	2	XX364
4	LINK	1	XX363
5	SPRING	1	XX371
6	SMALLEY RING	1	VR4340
7	SLIDER BLOCK	1	XX368
8	LATCHING PULL PIN SUBASSEMBLY	1	XX935
9	DETENT BUSHING	1	XX376
10	ARM	1	XX061
11	WASHER	1	XX377
12	SPRING	1	C031
13	SPRING RETAINER	1	XX378
14	1/4-20 X 1.75 SOCKET HEAD SCREW	1	VT25-20SH1.7
15	5/16-18 X 1 SOCKET HEAD SCREW	2	VT31-18SH1.0
16	SWIVEL TRUNNION	2	XX320
17	WAVE SPRING WASHER	2	VW740X550-16
18	EXIT SEGMENT	1	XX305
19	O-RING-235	1	VO-235
20	INLET BALL	1	XX015
21	O-RING-147	2	VO-147
22	WATERWAY	1	XX010
23	EXIT OSC 2.5"	1	XX020*
24	10-32 X 1/4 SOCKET SET SCREW	3	VT10-32SS250
25	10-32 X 1/2 BUTTON HEAD SCREW	5	VT10E32BH500
26	O-RING-153	1	VO-153
27	TURBINE VANES	1	XX025
28	5/32 X 7/8 HDP SPIROL PIN	1	V1900
29	TURBINE SEAL	1	XX032
30	WORM AND SHAFT	1	XX030
31	GEAR BOX	1	XX005
32	1/8 X 3/4 HDP SPIROL PIN	2	VP125X750H
33	10-32 X 1/2 BHCS - NYLOK PATCH	1	VT10Y32BH500
34	WASHER	1	VW500X203-60
35	OFFSET ROD END	1	XX057
36	SPHERICAL BUSHING	1	XX058
37	CRANK	1	XX362
38	CUP SEAL	1	XX033
39	WORM SHAFT BEARING	2	XX035
40	SNAP RING 1/2" EXTERNAL	2	VR4250
41	SNAP RING 1-1/8 INTERNAL	2	VR4255
42	O-RING-119	2	VO-119
43	SHAFT CAP	1	XX037
44	WORM GEAR	1	XX040
45	1/4-20 X 7/8 SOCKET HEAD SCREW	1	VT25-20SH875
46	COVER	1	XX045
* - CONSULT FACTORY FOR SPECIAL THREADS			

10.0 XXL-B Storage Bracket INSTALLATION INSTRUCTIONS

Tools Required: Electric Drill
Drill Bits see instructions for correct size
#3 Phillips Screw Driver
7/16 or adjustable wrench
5/32 allen wrench

The Blitz Force Portable Monitor storage bracket must be securely mounted to a surface capable of supporting the weight of the Monitor including any shock loads that may result from rough roads. The storage bracket may be mounted on a vertical surface, or a horizontal surface with the nozzle end pointing down or sideways as shown below. It is the responsibility of the installer to determine if the installation is capable of these loads.

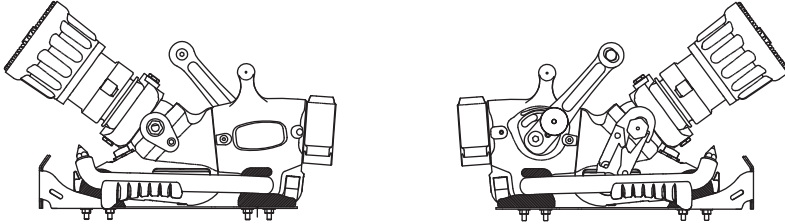
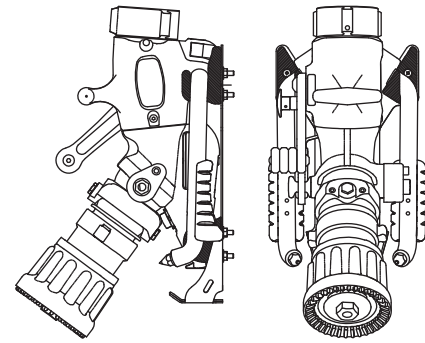

Do not use the Blitz Force Portable Monitor Storage Bracket as a mount when flowing water. Nozzle reaction will cause monitor instability. The Blitz Force Portable Monitor Storage Bracket is designed to store the Blitz Force Portable Monitor.

The Blitz Force Portable Monitor Storage Bracket comes with 1/4-20 Stainless Steel Self tapping screws, nuts and washers. If the material beneath the Storage Bracket is thick and substantial enough, the self-tapping screws may be screwed directly into the mounting surface. If the backside of the mounting surface is accessible, clearance holes may be drilled, and the nuts and washers may be used on the backside. It is the responsibility of the installer to determine if the mounting surface is satisfactory.

10.1 FOR BLIND MOUNTING:

Lay the bracket in the area where the monitor will be mounted. The end of the bracket with the bent & welded sides goes toward the monitor outlet. Make sure there is enough clearance to get the monitor in and out of the bracket and that it does not interfere with other equipment on the truck.

Make sure the material beneath the bracket is substantial and thick enough to hold self-tapping screws as well as the weight of the monitor. Make sure the area on the other side of the mounting surface is clear, you don't want to drill into a bundle of wires. We recommend a minimum thickness of 3/32" (.093" - 2.4 mm) in aluminum and 5/64 (.078"-2mm) in steel. Using the bracket as a pattern, drill through one hole into the mounting surface and install one screw. (Put washers on the screws before installing). See the chart on the next page to determine the correct hole size. While the first screw holds the bracket from moving, drill the remaining holes and screw in the remaining screws.

10.2 FOR MOUNTING WHERE THE BACK OF THE MOUNTING SURFACE IS ACCESSIBLE:

Lay the bracket in the area where the monitor will be mounted. The end of the bracket with the bent & welded sides goes toward the monitor outlet. Make sure there is enough clearance to get the monitor in and out of the bracket and that it does not interfere with other equipment on the truck.

Make sure the material beneath the bracket is substantial enough to hold the weight of the monitor. Make sure the area on the other side of the mounting surface is clear, you don't want to run a drill into a bundle of wires. Using the bracket as a pattern, drill one 1/4" (.250" - 6.4 mm) diameter hole through the bracket and bolt the bracket to the mounting surface from the backside. (Put the washers on the side with the nuts). While the first screw holds the bracket from moving, drill the remaining holes and screw in the remaining screws. Secure with washers and nuts.

10.3 MOUNTING BRACKET DIMENSIONS

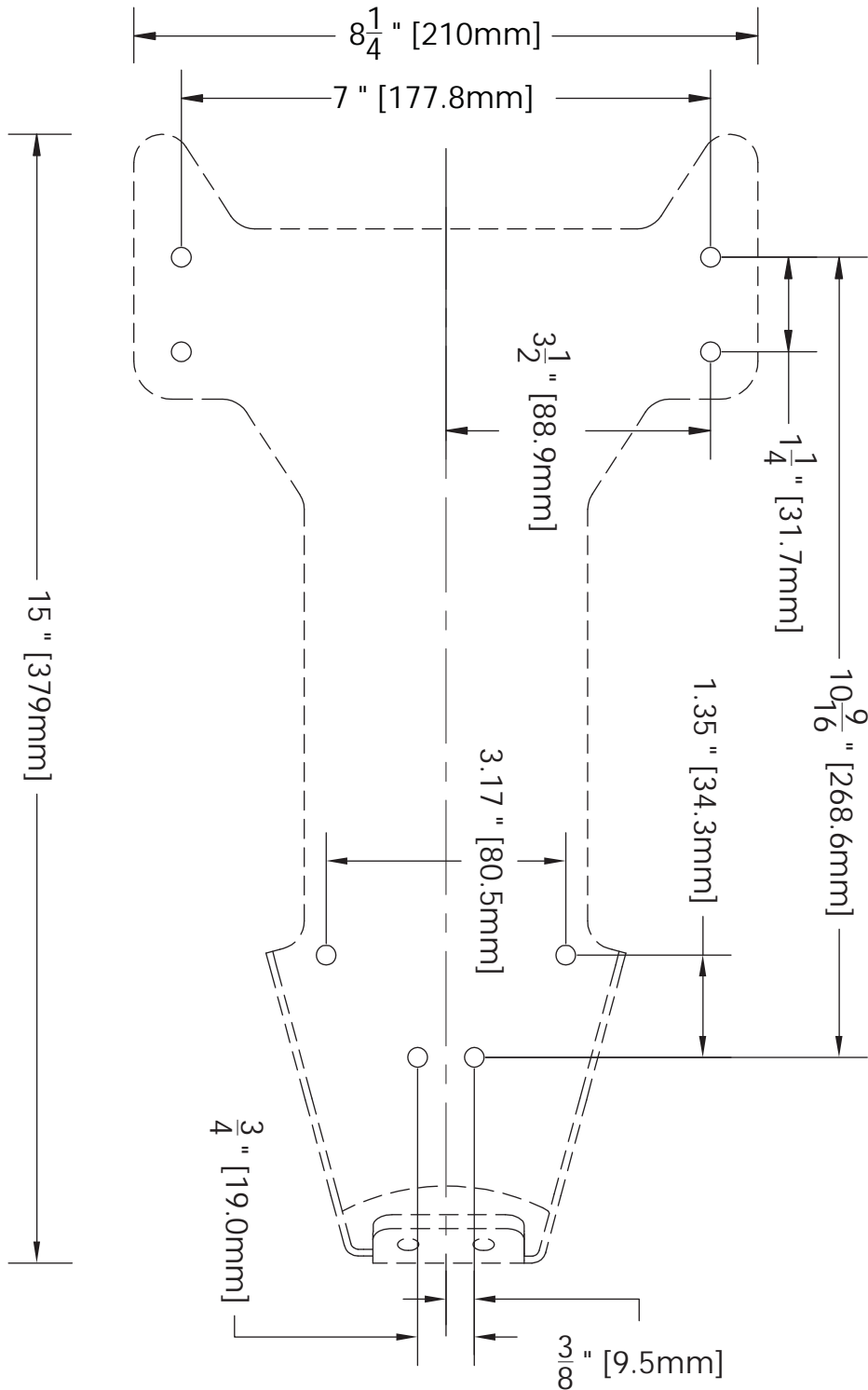

Hole Size Chart for Self Tapping Screws

ALUMINUM				STEEL			
Material Thickness	Inches	mm	Use Drill	Material Thickness	Inches	mm	Use Drill
5/64-3/32	.206	5.2	#5	3/32	.213	5.4	#3
1/8	.213	5.4	#3	1/8	.221	5.6	#2
3/16	.221	5.6	#2	3/16	.228	5.8	#1

11.0 BRACKET EXPLODED VIEW AND PARTS LIST

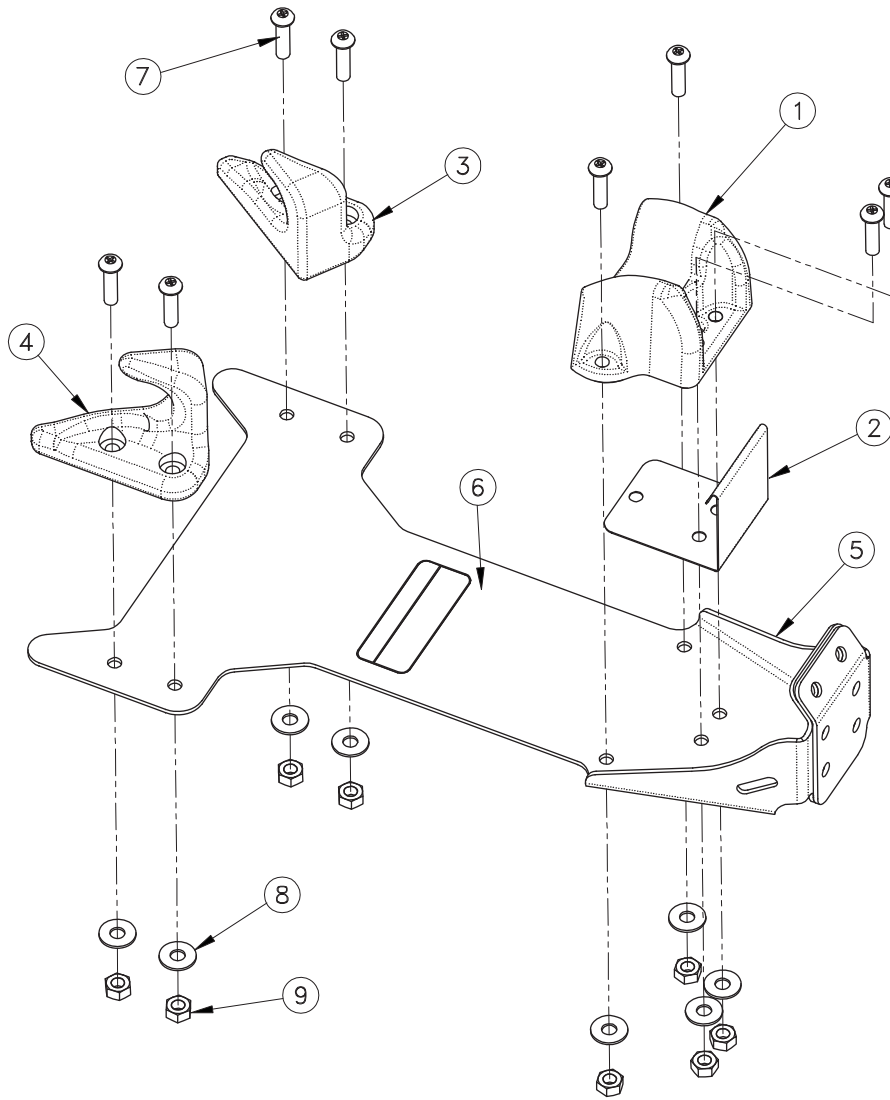

#	DESCRIPTION	QTY	PART#
1	FRONT SPIKE BRACKET	1	XXL491
2	LATCH	1	XX495
3	RIGHT LEG BRACKET	1	XXL492R
4	LEFT LEG BRACKET	1	XXL492L
5	SUPPORT BRACKET	1	XXL494
6	LABEL - STORAGE BRACKET BL	1	XXL695
7	1/4 - 20 x 1 SELF TAP SCREW	8	VT25-20ST1.0
8	1/4 STAINLESS WASHER	8	VW687X281-50
9	1/4 - 20 STAINLESS NUT	8	VT25-20NT

12.0 STATEMENT OF WARRANTY AND REPAIR

Task Force Tips, Inc., 3701 Innovation Way, Valparaiso, Indiana 46383-9327 USA ("TFT") warrants to the original purchaser of its nozzles and other equipment ("equipment"), and to anyone to whom it is transferred, that the equipment shall be free from defects in material and workmanship during the five (5) year period from the date of purchase.

TFT's obligation under this warranty is specifically limited to replacing or repairing the equipment (or its parts) which are shown by TFT's examination to be in a defective condition attributable to TFT. To qualify for this limited warranty, the claimant must return the equipment to TFT, at 3701 Innovation Way, Valparaiso, Indiana 46383-9327 USA, within a reasonable time after discovery of the defect. TFT will examine the equipment. If TFT determines that there is a defect attributable to it, it will correct the problem within a reasonable time. If the equipment is covered by this limited warranty, TFT will assume the expenses of repair.

If any defect attributable to TFT under this limited warranty cannot be reasonably cured by repair or replacement, TFT may elect to refund the purchase price of the equipment, less reasonable depreciation, in complete discharge of its obligations under this limited warranty. If TFT makes this election, claimant shall return the equipment to TFT free and clear of any liens and encumbrances.

This is a limited warranty. The original purchaser of the equipment, any person to whom it is transferred, and any person who is an intended or unintended beneficiary of the equipment, shall not be entitled to recover from TFT any consequential or incidental damages for injury to person and/or property resulting from any defective equipment manufactured or assembled by TFT. It is agreed and understood that the price stated for the equipment is in part consideration for limiting TFT's liability. Some states or countries do not allow the exclusion or limitation of incidental or consequential damages, so the above may not apply to you.

TFT shall have no obligation under this limited warranty if the equipment is, or has been, misused or neglected (including failure to provide reasonable maintenance) or if there have been accidents to the equipment or if it has been repaired or altered by someone else.

THIS IS A LIMITED EXPRESS WARRANTY ONLY. TFT EXPRESSLY DISCLAIMS WITH RESPECT TO THE EQUIPMENT ALL IMPLIED WARRANTIES OF MERCHANTABILITY AND ALL IMPLIED WARRANTIES OF FITNESS FOR A PARTICULAR PURPOSE. THERE IS NO WARRANTY OF ANY NATURE MADE BY TFT BEYOND THAT STATED IN THE DOCUMENT.

This limited warranty gives you specific legal rights, and you may also have other rights which vary from state to state

13.0 OPERATION CHECKLIST

Monitor must be inspected for proper operation and function according to this checklist before each use. Before flowing water check:

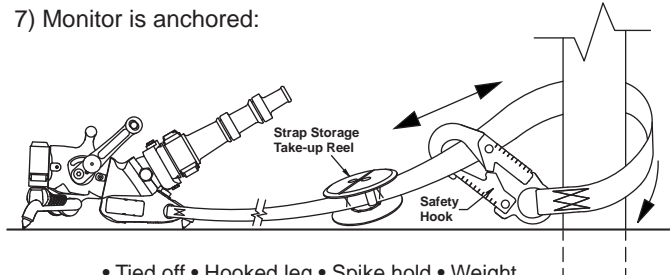
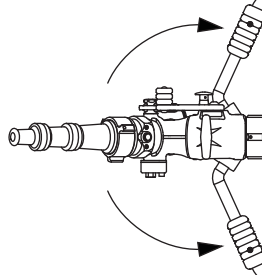
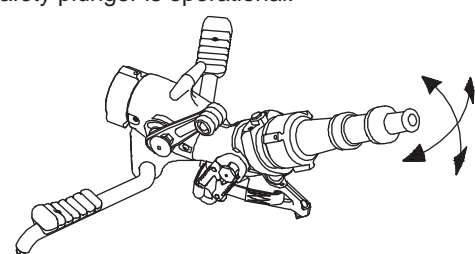
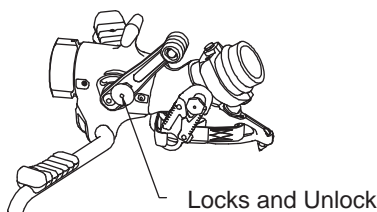
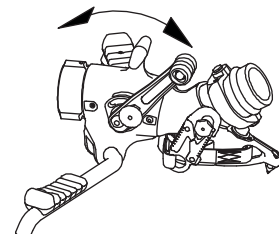
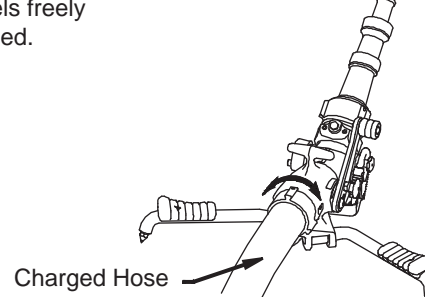
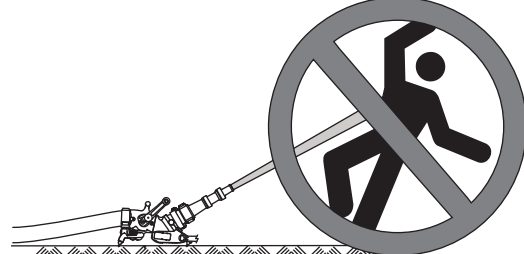
<p>1) There is no obvious damage such as missing, broken or loose parts. 2) Hose and nozzle are securely attached.</p>	<p>7) Monitor is anchored:</p>  <p>• Tied off • Hooked leg • Spike hold • Weight</p>
<p>3) Both legs are fully open. 4) All three spikes are in contact with the ground.</p> 	<p>8) Outlet pivots smoothly in both directions and elevation safety plunger is operational.</p> 
<p>5) Valve handle locks when closed and releases.</p>  <p>Locks and Unlocks</p>	<p>9) Shut-Off valve is operational. (see section 2.2)</p> 
<p>8) Inlet coupling swivels freely when hose is charged.</p>  <p>Charged Hose</p>	<p>10) Monitor is pointed in a safe direction.</p> 

WARNING Any Blitz Force Portable Monitor failing any part of the inspection checklist is unsafe and must have the problem corrected before use. Operating a Blitz Force Portable Monitor that fails any of the above inspections is a misuse of this equipment.

For additional information on care, maintenance and testing, refer to: **NFPA 1962: Standard for the Care, Use, Inspection, Service Testing, and Replacement of Fire Hose, Couplings, Nozzles, and Fire Hose Appliances, 2013 Edition**